

Step 1

After post has been installed determine height of bottom rail to stair tread. (Install tip: 1 x 6 or 2 x 4 lumber may be used as a spacer.)

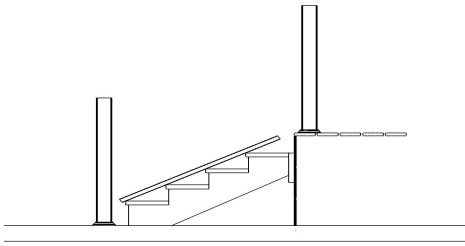

Step 2

Assemble rail section. Set rail section on top of spacer and against post. Using a level hold railing section at proper pitch then shift section up or down creating equal baluster spacing for each post. After rail is a proper position hold in place with clamps.

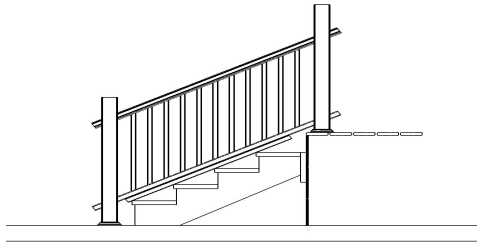

Step 3

Align Angle Wizard bracket in position establishing bracket height and the angle rotation of bracket. Mark rail with pencil mark, you will need to add 7/8" to length of rail from pencil mark. This 2nd mark will be the cut line for rail ends. Repeat this step for each end.

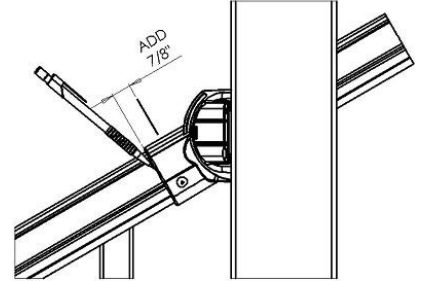

Step 4

After all ends of the rails have 1st mark established remove clamps from rail assembly. Now pencil mark the additional 7/8" to rail ends as described at step 3 (the 2nd mark) and cut rail ends to length.

Step 5

After cutting rail ends place Angle Wizards over the ends of each rail. Set rail section back on the spacer and this time between the post re-establishing pitch of bracket angle and clamp into position.

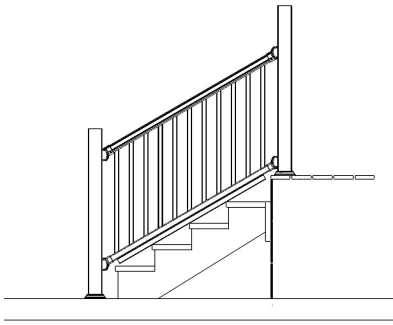

Step 6

Pencil mark for the (4) screw holes at each bracket.

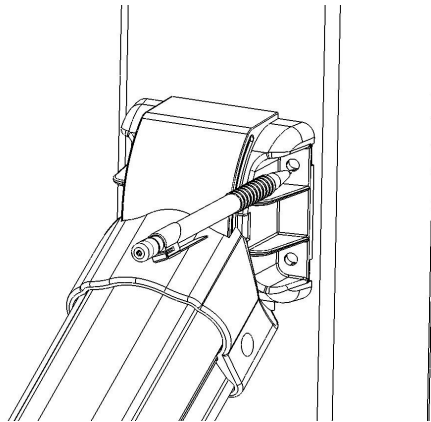

Step 7

Pencil mark the position that the bracket is at along with the base.

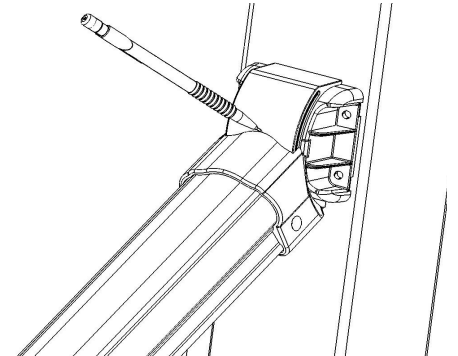

Step 8

Remove clamp from rail assembly and remove rail assembly from between post. Then pre-drill marked holes (from step 6) in post with a 1/8" diameter drill bit.

Step 9

Remove bracket from ends of rail assembly. Aligning bracket and base with the pencil mark from step 7 fasten with (2) #10 x 1-1/2" Pan Head screws supplied as shown below. Bottom bracket uses (1) #10 x 1" Pan Head screw. Repeat this for each bracket.

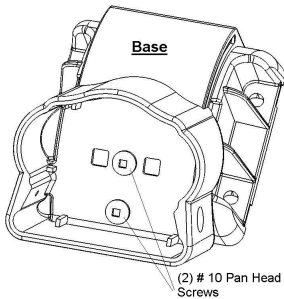

Step 10

Place brackets back on rail ends, then place rail assembly on spacer. Fasten brackets to post using screws provided aligning brackets to pre-drilled holes (from step 8).

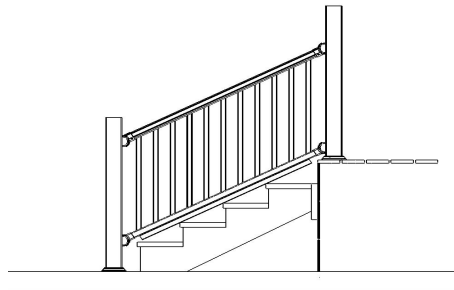

Step 11

Once (4) brackets are fastened to post, then pre-drill thru bracket, rail, and aluminum rail insert (if used) with a 1/8" drill bit (2 places each bracket) then fasten with supplied (2) # 10 x 1" flat head screws as shown below. Repeat this step for each bracket.

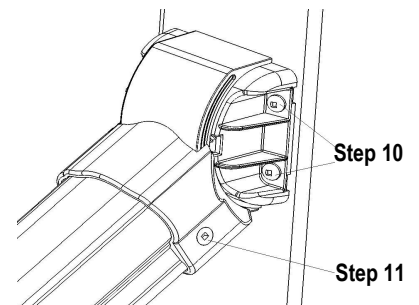

Step 12

Add (2) screw covers and 2 screw caps for each bracket.

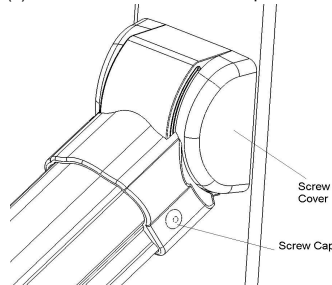

Special Note:

Top Bracket uses (6) # 10 x 1-1/2" Screws & (2) #10 X 1" Flat Head Screws
Bottom Bracket uses (5) # 10 x 1" Screws

Angle Wizard Deluxe Stair Rail Bracket Kit
19-AW24-DLX-SR-MAX-KIT

Note:

Repeat installation process for each additional rail assembly. Top Bracket shown only.

Angle Wizard Max Stair Instructions

Important Information Before you Start

These installation guidelines will direct you through the process of installing the Angle Wizard stair brackets. Most contractors will find this process very similar, if not identical to the installation of a regular stair rail system. There are, however, certain areas that you will want to pay closer attention to.

This sheet depicts installation methods that have been proven successful and are therefore recommended by the manufacturer. Please keep in mind that they may not cover every installation scenario you may encounter. Since each installation is unique in its performance requirements, the ultimate installation method used is the sole responsibility of the installer.

The Manufacturer disclaims any liability or responsibility for the improper installation of this product. The purchaser is solely responsible for compliance with applicable local codes as to the deck's or railing's intended use. The Manufacturer recommends that all designs be reviewed by a licensed architect, engineer or local building official before installation.

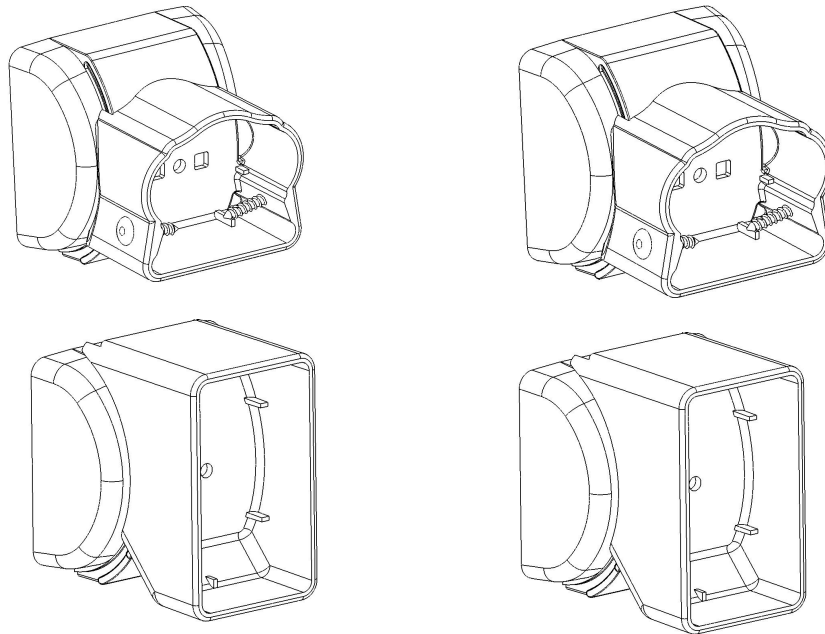

Tools Required for Installation



Tape Measure



Pencil

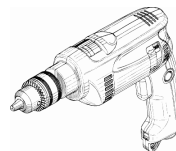

Drill



#2 square Screwdriver

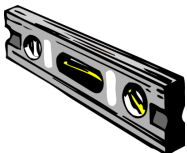

Level

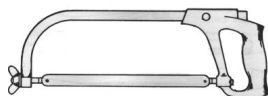

Hack Saw



Miter Saw



Rubber Mallet